

## CV355-30X-NDI

30X NDI®|HX Box Camera



## User Manual

# Table of Contents

- 1. Safety Instructions ..... 04
- 2. Package Contents ..... 06
- 3. Function Introduction ..... 06
  - 3.1 I/O Functions Introduction ..... 06
  - 3.2 Tally Indicator Light Function Description ..... 07
- 4. Installation Instructions ..... 07
  - 4.1 Installation Basics ..... 07
  - 4.2 Connecting Devices ..... 08
- 5. Network Function Settings ..... 11
  - 5.1 Web System Requirements ..... 11
  - 5.2 Connecting Camera to Network ..... 11
  - 5.3 Web Page Function Description ..... 14
- 6. Specifications ..... 26
- 7. Troubleshooting ..... 27
- Warranty ..... 28

# Copyright Information

Copyrights © Marshall Electronics Incorporated. All rights reserved.

Marshall Electronics is a trademark of Marshall Electronics Incorporated

Copying, reproducing or transmitting this file is not allowed if a license is not provided by Marshall Electronics Inc. unless copying this file is for the purpose of backup after purchasing this product.

In order to keep improving the product, Marshall Electronics Inc. hereby reserves the right to make changes to product specifications without prior notice. The information in this file is subject to change without prior notice.

To fully explain or describe how this product should be used, this manual may refer to names of other products or companies without any intention of infringement.

Disclaimer of warranties: Marshall Electronics Inc. is neither responsible for any possible technological, editorial errors or omissions, nor responsible for any incidental or related damages arising from providing this file, using, or operating this product.

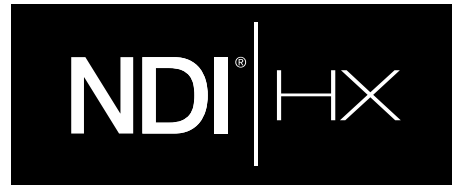

### Understanding Quick setup of CV355-30X-NDI with NDI@|HX

This section explains how to quickly configure the Marshall CV355-30X-NDI camera with NDI@|HX.

It also explains how to update the device, and where you can find additional NDI software to extend your workflow. Complete NDI@ Tools can be found here: <https://www.ndi.tv/tools/>

Here you will choose whether you will require NDI@ Tools for Windows or Mac and download.

After completing this short section, you will be all set to begin using your new NDI@|HX camera.

**OVERVIEW:** Unlike typical cameras, CV355-30X-NDI leverages the easy plug-n-play benefits of the NDI-based IP workflow supported by leading video software and hardware developers around the globe.

**GETTING READY:** Your new CV355-30X-NDI uses the NDI@|HX protocol for audio/video transmission, and more. Your first step will be to install NDI@|HX drivers if using a TriCaster, or Microsoft HEVC decode on non-TriCaster systems, as appropriate for your computer platform or device.

1. Navigate to [ndi.tv/formats](https://www.ndi.tv/formats) in your web browser and follow the relevant directions to download and install the drivers for your computer platform. NOTE: The NDI@|HX driver also installs NewTek's NDI Studio Monitor application, which will not only display the output of your camera but also provide easy access to its settings. Also contains built-in PTZ controls.
2. NDI Studio Monitor and other useful NDI tools can be found here: <https://www.ndi.tv/tools/>
3. Then simply plug the Ethernet (NDI) port to same Network your computer or Newtek equipment are plugged into and off you go.

**NOTE:** The End User License Agreement under which you use the NDI@|HX driver specifies that "you may use up to five (5), and no more than five, copies on separate machines at one time."

**OPTIONAL** – for Microsoft Windows® users, downloading and installing the NewTek NDI@ Tools pack, available at no cost from [ndi.tv/tools/](https://www.ndi.tv/tools/), the download pack will provide learning tools and utilities to maximize your NDI@|HX experience.

**FINAL NOTE** – if you are experiencing any problems with the NDI@ platform, NDI@ software, NDI@ drivers please contact Newtek for technical assistance or join the NDI community to review HOW-TO videos, social media, forums, blogs: [www.ndi.tv/community](https://www.ndi.tv/community)

If you are having a hardware problem, and need assistance please contact Marshall Electronics.

Marshall Customer Support

Toll Free: 800-800-6608 or 310-333-0606

Email: [support@marshall-usa.com](mailto:support@marshall-usa.com)

## 1. Safety Instructions

### 1. Operation

- 1.1 Please use the product in the recommended operating environment.
- 1.2 Do not place the product in tilted position.
- 1.3 Do not place the product on an unstable trolley, stand or table.
- 1.4 Do not use the product near water or source of heat.
- 1.5 Use attachments only as recommended.
- 1.6 Use the type of power source indicated on the product. If you are not sure of the type of power available, consult your distributor or local electricity company for advice.
- 1.7 Always take the following precautions when handling the plug. Failure to do so may result in sparks or fire:
  - Ensure the plug is free of dust before inserting it into a socket.
  - Ensure that the plug is inserted into the socket securely.
- 1.8 Do not overload wall sockets, extension cords or multi-way plug boards to avoid potential risks.
- 1.9 Do not block the slots and openings in the case of the product. They provide ventilation and prevent the product from overheating.
- 1.10 Except as specifically instructed in this User Manual, do not open or remove covers, otherwise it may expose you to dangerous voltages and other hazards. Refer all servicing to licensed service personnel.
- 1.11 Unplug the product from the wall outlet and refer servicing to licensed service personnel when the following situations happen:
  - If the power cords are damaged or frayed.
  - If liquid is spilled into the product or the product has been exposed to rain or water.

### 2. Installation

- 2.1 For security considerations, please make sure the standard hanging rack you bought is in line with UL or CE safety approbations and installed by technician personnel approved by agents.

### 3. Storage

- 3.1 Do not mount camera where power cord can be stepped on, as this may result in fraying or damage to the lead or the plug.
- 3.2 Never push objects of any kind through cabinet slots. Never allow liquid of any kind to spill onto or into the camera body.
- 3.3 Unplug this product during thunderstorms, during electrical surges, or if it is not going to be used for an extended period of time.
- 3.4 Do not place camera or accessories on top of vibrating equipment or heated objects.

## 4. Cleaning

- 4.1 Unplug all the cables before cleaning. Use a damp cloth for cleaning. Do not use liquid or aerosol cleaners or allow any liquids to enter camera body.

## 5. Remote Control (if applicable)

- 5.1 Using an incorrect battery type in the remote control may result in breakdown. Follow local instructions on how to dispose of used batteries.

## Precautions

**Warning: To reduce the risk of fire or electric shock, do not expose this camera to rain, moisture, debris or liquids.**

If the HD camera will not be used for an extended time, unplug it from the power socket.



**Caution:** To reduce the risk of electric shock, do not remove cover (or back). No user-serviceable parts inside. Refer servicing to licensed service personnel. Please do not open it by yourself



This symbol indicates that this equipment may contain dangerous voltage which could cause electric shock.



This symbol indicates that there are important operating and maintenance instructions in this User Manual with this unit.

## FCC Warning

This product has been tested and found to comply with the limits for a Class B computer device, pursuant to Article 15-J of FCC Rules. These limits are designed to provide reasonable protection against harmful interference in a residential installation.

This digital apparatus does not exceed the Class B limits for radio noise emissions from digital apparatus as set out in the interference-causing equipment standard entitled "Digital Apparatus" ICES-003 of Industry Canada.

Cet appareil numérique respecte les limites de bruits radioélectriques applicables aux appareils numériques de Classe B prescrites dans la norme sur le matériel brouilleur: "Appareils Numériques," NMB-003 édictée par l'Industrie.

## EN55032 (CE Radiation) Warning

Operation of this equipment in a residential environment could cause radio interference.

## 2. Package Contents

CV355-30X-NDI

Power Cord

Power Adapter



\*Appearance may vary depending on country/region

## 3. Function Introduction

### 3.1 I/O functions Introductions

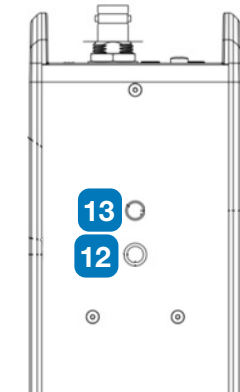

No.	Item	Function Description
1	Lens	30x HD camera lens
2	Tally indicator light	Display the tally light status of the camera
3	Network port	Network port, support routers or hubs (IEEE 802.3 af) with PoE power supply support
4	3G-SDI output	The factory setting for the output resolution is 1080P/60
5	Power indicator light	After power is on, the indicator light will display in red
6	DC 12 V power connector	AC power supply connecting port
7	RS232 output	RS232 output port, at most 7 cameras can be connected in a serial connection
8	RS232 input	RS232 input port, at most 7 cameras can be connected in a serial connection
9	HDMI output	HDMI output
10	Audio input	Support Line In/Mic In
11	Audio output	Support 3.5 mm audio input
12	Tripod screw holes	The camera is mounted on a (specification) 1/4", 20 UNC tripod deck or installed on VC-WM11 (optional)
13	Fiducial hole	Ø5; depth 2mm

## 3.2 Tally Indicator Light Function Description

**3.2.1** The tally indicator light function may be enabled through the control of VISCA command.

The setting method is as follows:

Tally Mode : 8x 01 7E 01 0A 01 0p FF

p = 0 : OFF

p = 4 : On (half-brightness)

p = 5 : On (full-brightness)

## 4. Installation Instructions

### 4.1 Installation Basics

#### 4.1.1 CV355-30X-NDI Dimensions

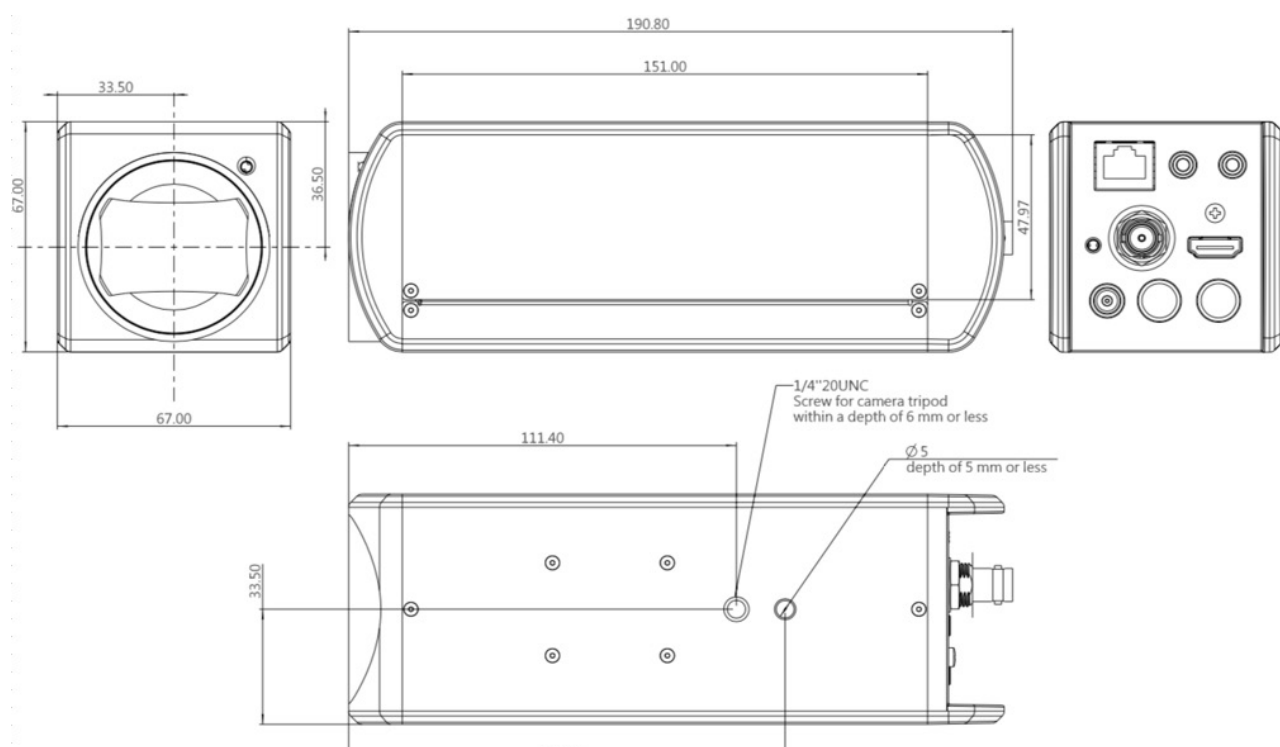

## 4.2 Connecting devices

### 4.2.1 Using HDMI/3G-SDI connect to the screen

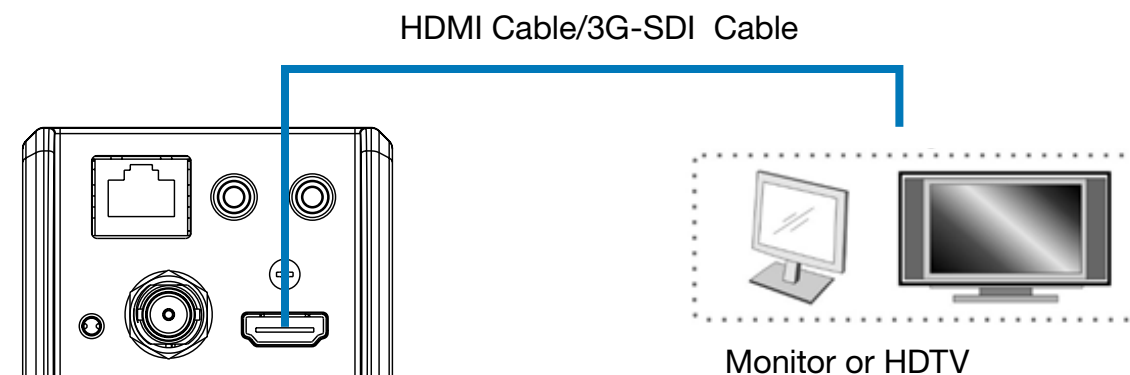

### 4.2.2 Connecting to Internet

For details of web page connection setting and description, please refer to Chapter 5 Network Function Settings Description.

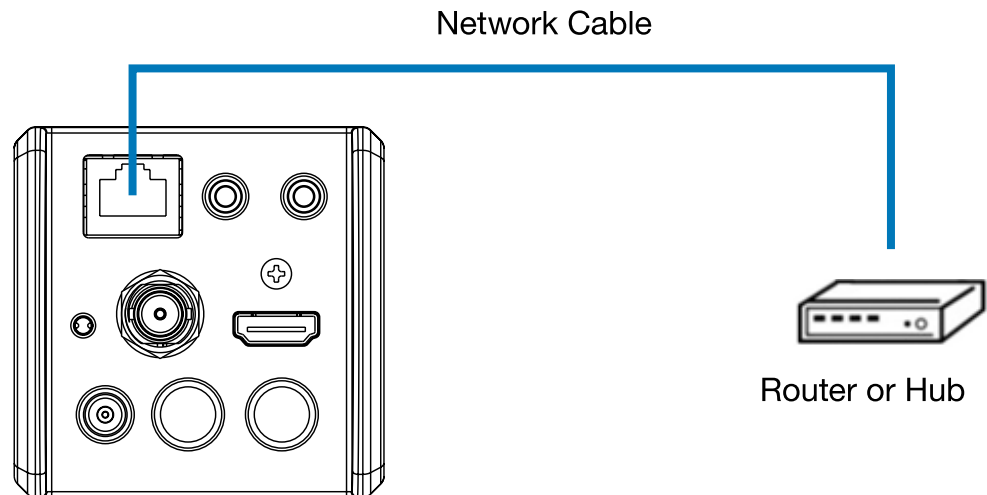

### 4.2.3 Connecting AUDIO IN

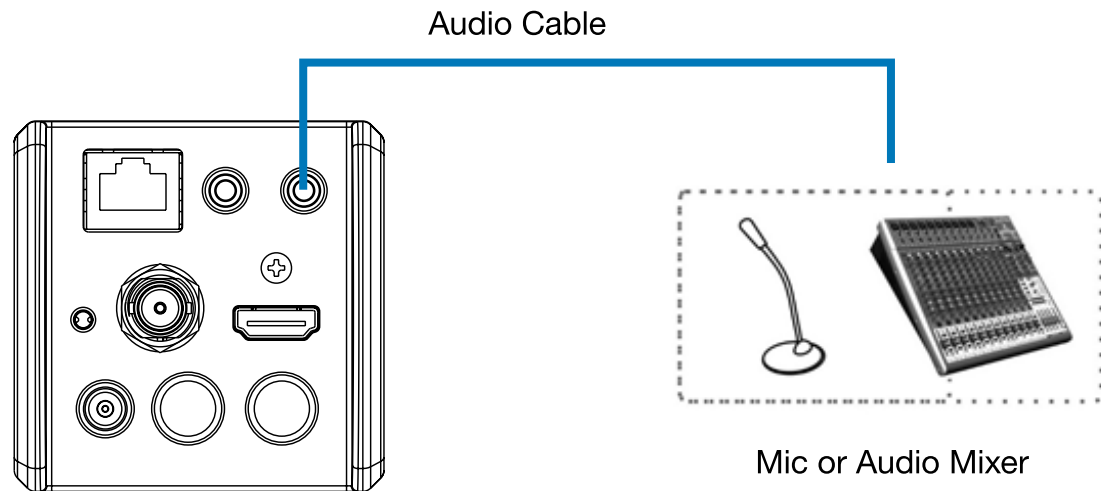

### 4.2.4 Connecting RS-232

- RS-232 serial connection

With RS-232 in/out, at most 7 Marshall cameras can be connected.

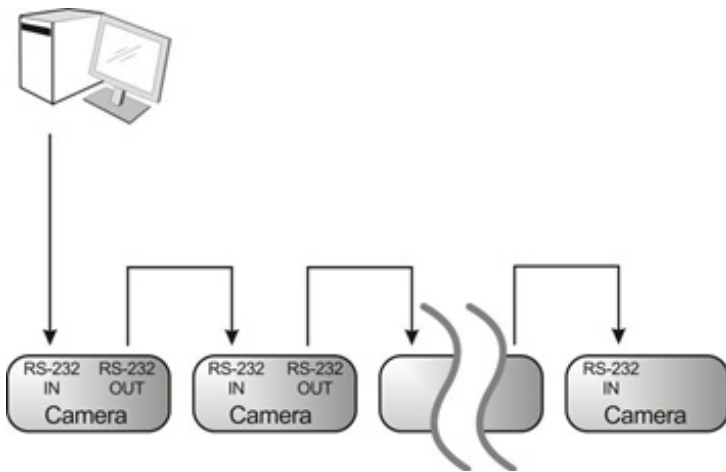

- RS-232 pin definition description

#### RS-232 IN Pins Instructions

NO	Pins	Signals
1	DTR	Data Transmission Reade
2	DSR	Data Set Reade
3	TXD	Transmit Data
4	GND	Ground
5	RXD	Receive Data
6	GND	Ground
7	IR OUT	IR Commander Signal
8	N.C.	No Connection

#### RS-232 OUT Pins Instructions

NO	Pins	Signals
1	DTR	Data Transmission Reade
2	DSR	Data Set Reade
3	TXD	Transmit Data
4	GND	Ground
5	RXD	Receive Data
6	GND	Ground
7	OPEN	Reserved
8	OPEN	Reserved

#### RS-232 Connection Instructions

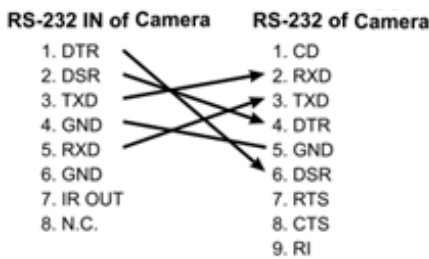

#### RS-232 Connection Instructions

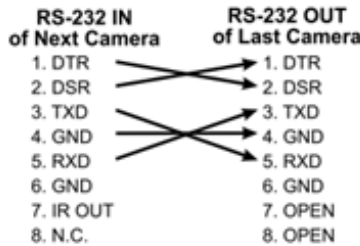

## 5. Network Function Settings

### 5.1 Web System Requirements

#### 5.1.1 Web Browser:

- Internet Explorer 11 or above
- FireFox 66.0.3 or above
- Chrome 73 or above
- Edge 42.17134 or above
- Safari 12.1 or above

### 5.2 Connecting Camera to Network

#### 5.2.1 Connecting to Internet

Two common connection methods are shown below

##### 1. Connecting via switch or router

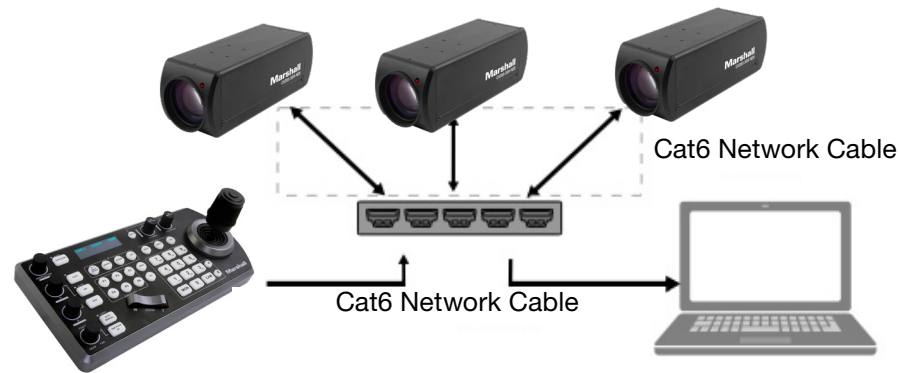

- ##### 2. If the camera is connected to the computer directly, the computer IP address must be modified to have the same network segment as the camera.
- For example, the factory-preset default IP address of CV355-30X-NDI is 192.168.100.100. The computer IP address must be set with the same subnet, such as 192.168.100.101, so that the computer can be connected correctly with the camera

- Connection Diagram

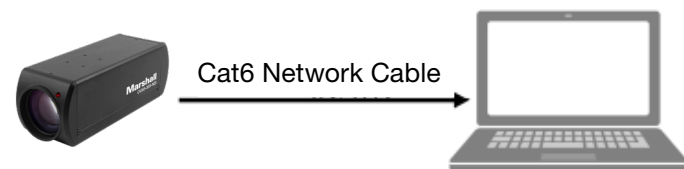

- Change network settings

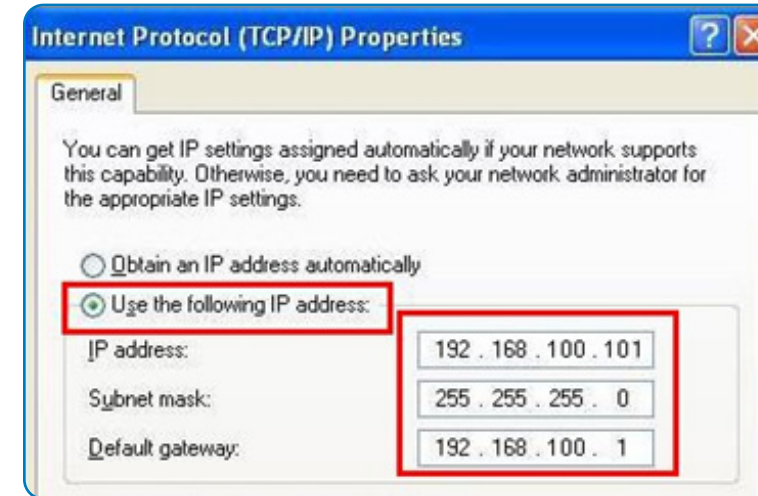

5.2.2 Using the Browser to View the Images

- Open the browser, and enter the URL of CV355-30X-NDI in the IP address bar  
e.g.: http://192.168.100.100 (default IP address)
- Enter administrator’s account and password  
Account: admin (Default)  
Password: 9999 (Default)



5.3 Web Page Function Description

5.3.1 Login Screen



No.	Item.	Function Descriptions
1	Username	Enter user account name (default: admin)
2	Password	Enter user password (default: 9999)
3	Language selection	The system currently supports English, Traditional Chinese, and Simplified Chinese
4	Remember password	Saves user account name and password to the browser.
5	Login	Log into the administrator screen on the website



### 5.3.2 Viewing In Real Time

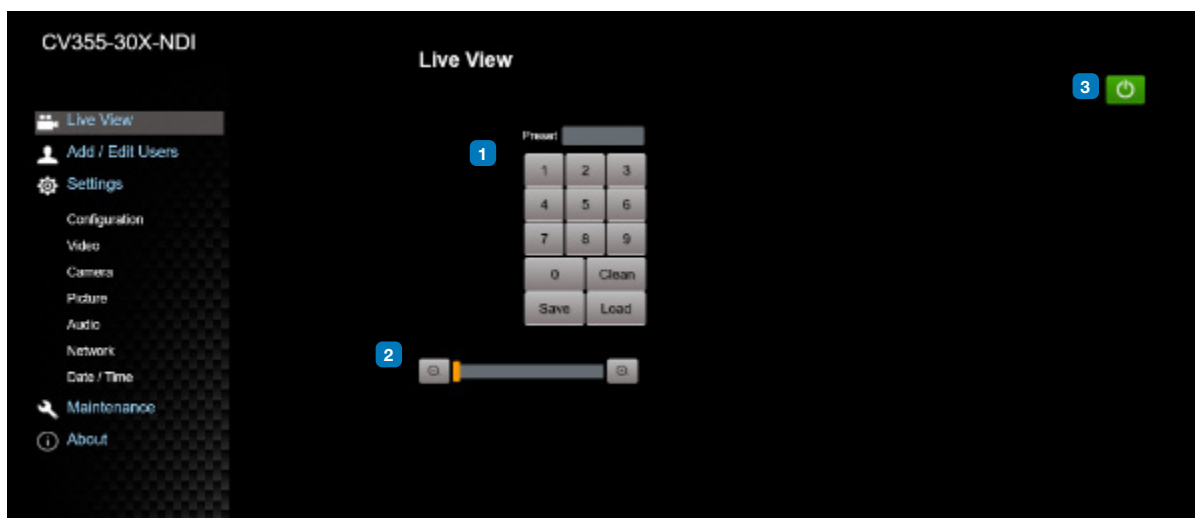

No.	Item.	Function Descriptions
1	Preset setting	Select the number first and then select SAVE or LOAD
2	Zoom ratio	Adjust the zoom-in or zoom-out ratio via scroll bar
3	Power button	Turn on or turn off the camera power

### 5.3.3 Account Management

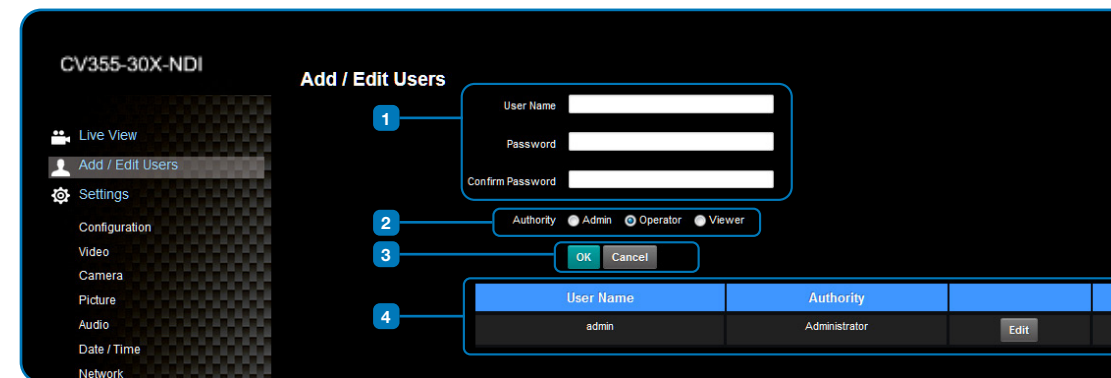

No.	Item.	Function Descriptions																
1	Add user account	Enter a username and password to add a new user																
2	Permission setting	Set the new account management permissions <table border="1" style="margin-left: 20px;"> <thead> <tr> <th>User Type</th> <th>Admin</th> <th>Operator</th> <th>Viewer</th> </tr> </thead> <tbody> <tr> <td>View images</td> <td>Y</td> <td>Y</td> <td>Y</td> </tr> <tr> <td>Settings</td> <td>Y</td> <td>Y</td> <td>N</td> </tr> <tr> <td>Account management</td> <td>Y</td> <td>N</td> <td>N</td> </tr> </tbody> </table>	User Type	Admin	Operator	Viewer	View images	Y	Y	Y	Settings	Y	Y	N	Account management	Y	N	N
User Type	Admin	Operator	Viewer															
View images	Y	Y	Y															
Settings	Y	Y	N															
Account management	Y	N	N															
3	Applying setting	Add the newly created user to the account list																
4	List of accounts	Edit: Modify the user password and permissions Delete: Delete the user account																

**5.3.4 System Configurations**

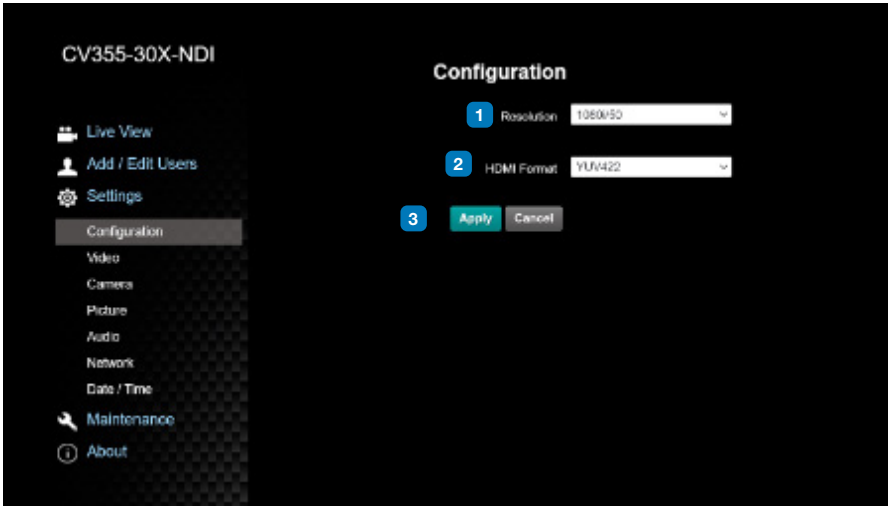

No.	Item.	Function Descriptions
1	Resolution	Set the resolution of the camera, resolutions supported by the camera are as follows: <ul style="list-style-type: none"> <li>• 1080p 59.94/50/29.97/25</li> <li>• 1080i 59.94/50</li> <li>• 720p 59.94/50</li> </ul> After switching the resolution, the camera will restart. If there are no images on the website, please refresh the browser
2	HDMI Format	Set HDMI color format YUV422 or RGB
3	Apply	After the setting has been modified, select this button to apply the setting

**5.3.5 Video Settings**

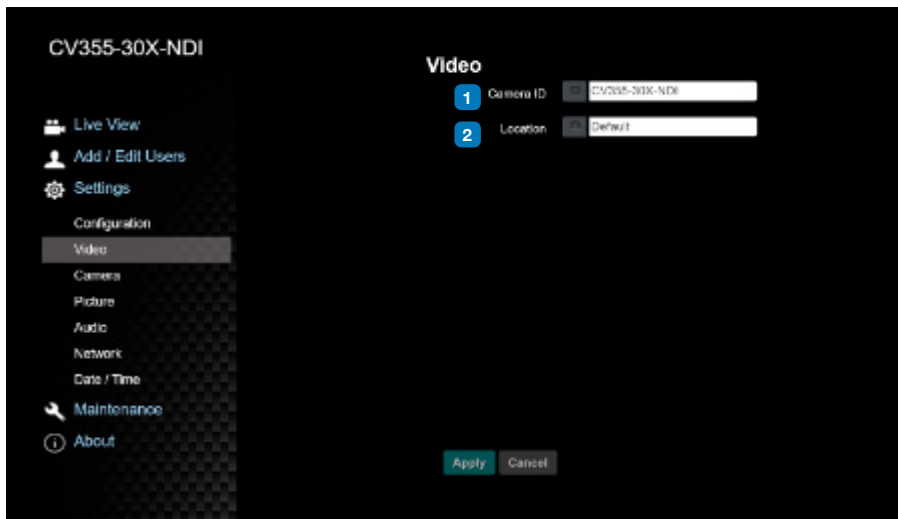

No.	Item.	Function Descriptions
1	Camera name	Modify the camera name <ul style="list-style-type: none"> <li>• Camera names are limited to 1-12 characters</li> <li>• Please use a camera name by mixing uppercase and lowercase letters and numbers. Do not use "/" and "space" or special symbols</li> </ul>
2	Camera location	Modify the location of the camera, such as Meeting Room 1 <ul style="list-style-type: none"> <li>• Camera locations are limited to 1-12 characters</li> <li>• Please use a camera name by mixing uppercase and lowercase letters and numbers. Do not use "/" and "space" or special symbols</li> </ul>

### 5.3.6 Camera Settings

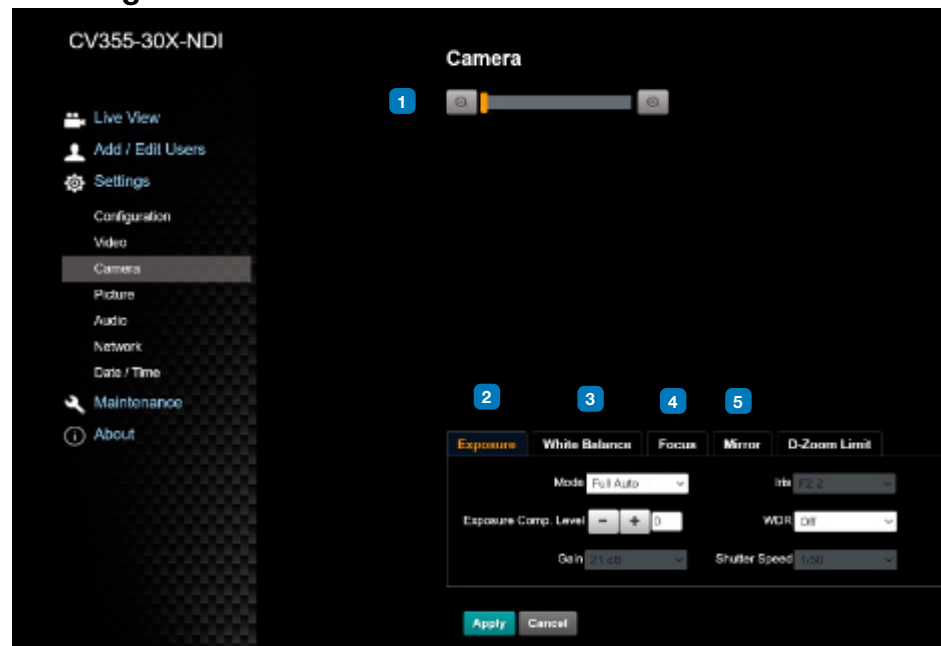

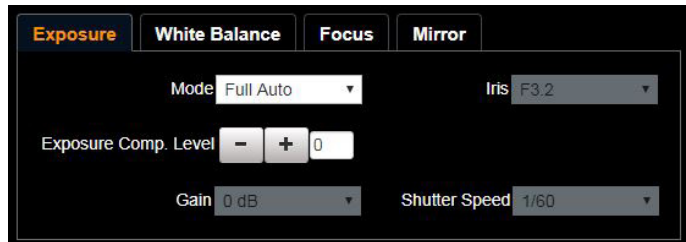
No.	Item.	Function Descriptions
1	Zoom ratio	Adjust the zoom-in or zoom-out ratio via scroll bar
2	Exposure	 <ul style="list-style-type: none"> <li>• <b>Mode:</b> Select exposure mode (Automatic/Shutter Priority/Aperture Priority/Manual)</li> <li>• <b>Exposure Comp. Level:</b> Select exposure compensation level</li> <li>• <b>Gain:</b> The gain limit is adjustable when the exposure mode is set to “Manual”</li> <li>• <b>Iris:</b> The size of aperture is adjustable when the exposure mode is set to “Manual” or “Aperture Priority”</li> <li>• <b>WDR:</b> Set the level of wide dynamic range (WDR) in order to obtain better images in dynamic lighting environments.</li> <li>• <b>Shutter Speed:</b> The shutter speed is adjustable when the exposure mode is set to “Manual” or “Shutter Priority”</li> </ul>

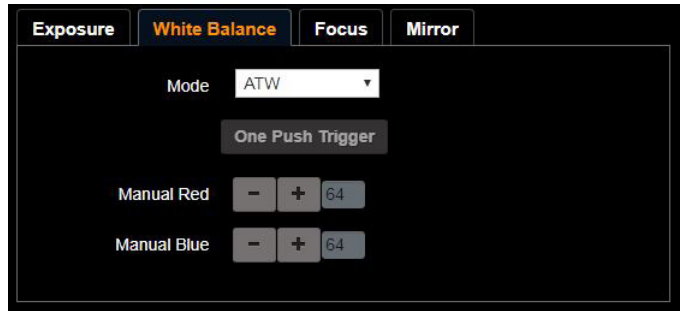
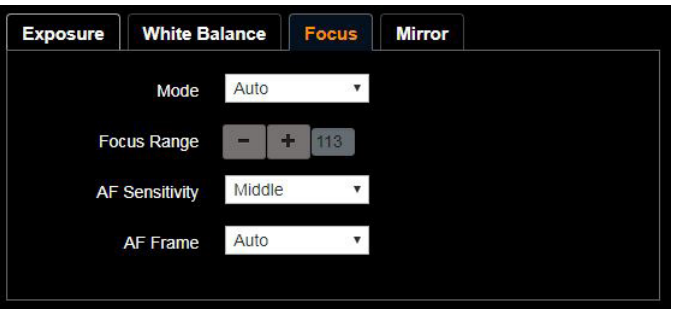
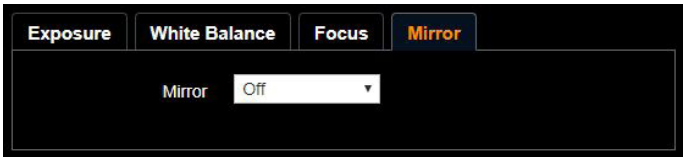
3	White balance	 <ul style="list-style-type: none"> <li>• <b>Mode:</b> Select the color temperature mode                             <ul style="list-style-type: none"> <li>• Auto</li> <li>• Indoor</li> <li>• Outdoor</li> <li>• One Push WB</li> <li>• ATW</li> <li>• Manual</li> <li>• Sodium Lamp</li> </ul> </li> <li>• <b>One Push Trigger:</b> One push color temperature is adjustable when the white balance mode is set to “One Push Trigger”</li> <li>• <b>Manual Red/Blue:</b> Manually adjust blue/red color temperature</li> </ul>
4	Focus	 <ul style="list-style-type: none"> <li>• <b>Mode:</b> Select manual/automatic focus</li> <li>• <b>Focus Range:</b> The focusing range is adjustable when the focus mode is set to “Manual”</li> <li>• <b>AF Sensitivity:</b> Set automatic focus sensitivity</li> <li>• <b>AF Frame:</b> Set automatic focus range</li> </ul>
5	MIRROR	 <ul style="list-style-type: none"> <li>• <b>Mirror:</b> Set the mode at which the image is mirror and flipped                             <ul style="list-style-type: none"> <li>• Off</li> <li>• Mirror</li> <li>• Flip</li> <li>• Mirror + Flip</li> </ul> </li> </ul>

5.3.7 Picture Settings

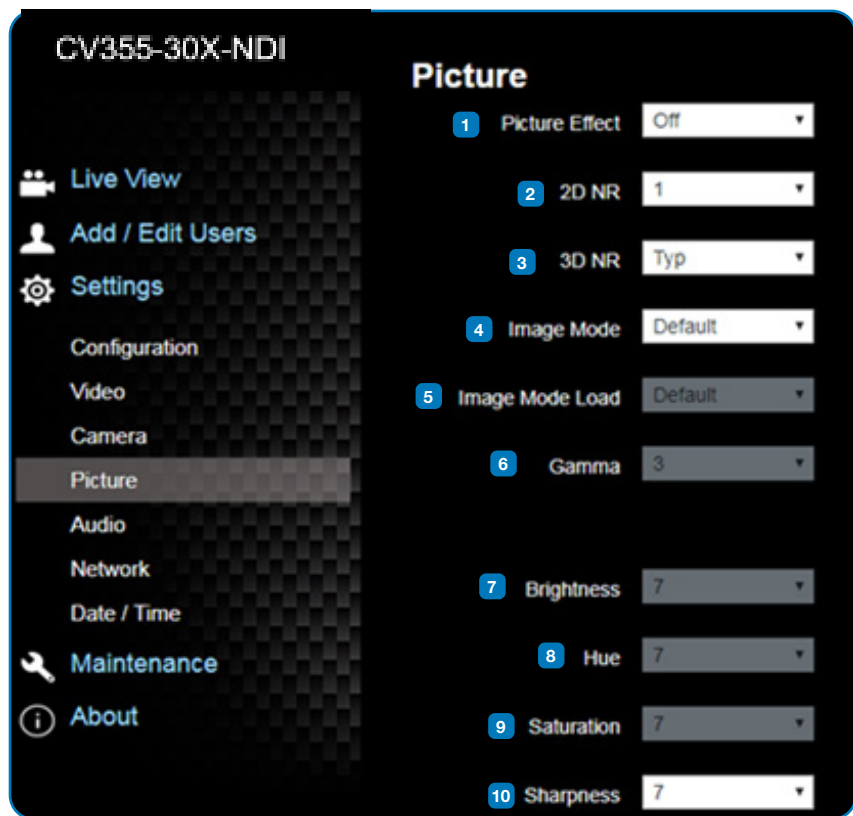

No	Item	Function Descriptions
1	Picture effect	Set picture effect, Off / Film / Black and White
2	2D noise reduction settings	2D noise reduction settings
3	3D noise reduction settings	3D noise reduction settings
4	Image mode	The user may customize his/her desired image mode
5	Image mode load*	When no custom setting is needed, reset the picture parameters back to the factory default by selecting this item
6	Gamma*	Gamma Level adjustment; Adjustable when the image mode is set to Custom
7	Brightness*	Brightness adjustment; Adjustable when the image mode is set to Custom
8	Contrast*	Contrast adjustment; Adjustable when the image mode is set to Custom
9	Saturation*	Saturation adjustment; Adjustable when the image mode is set to Custom
10	Sharpness*	Adjust the sharpness of the image

\*Setting only enabled when image mode set to custom

5.3.8 Audio Settings

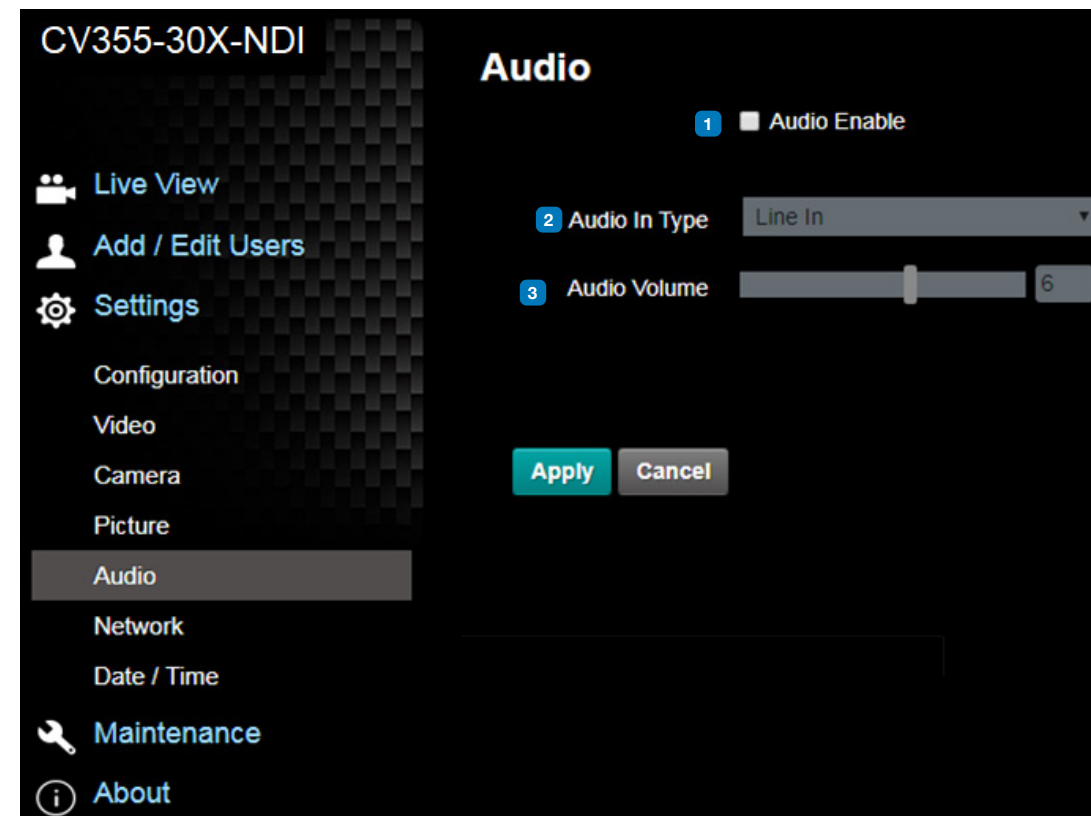

No.	Item.	Function Descriptions
1	Audio Enable	Turn on/off sound
2	Audio In Type	Set MIC In/Line In
3	Audio Volume	Adjust Volume

5.3.9 Network Settings

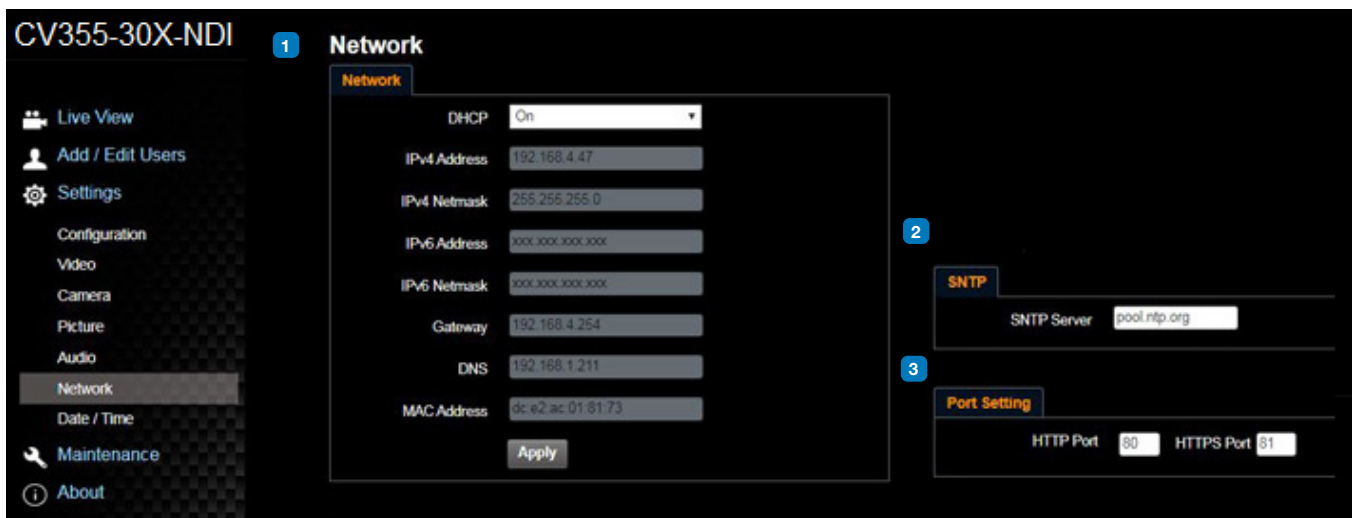

No.	Item.	Function Descriptions
1	Network	Network setting of camera. Change of setting is available only when DHCP function is closed.
2	SNTP Setting	Set SNTP Server IP
3	Port Setting	Set HTTP and HTTPS ports. The default values are Port 80 and Port 81 respectively <Remark> Change of setting is available only when DHCP function of camera is closed

5.3.10 Time Settings

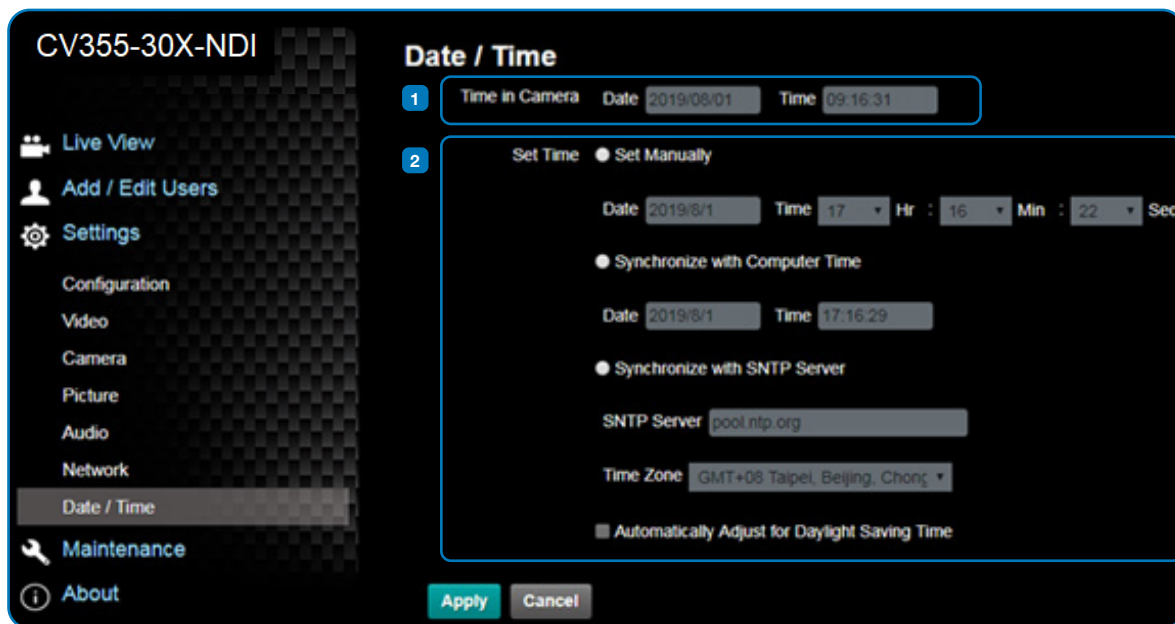

No.	Item.	Function Descriptions
1	Camera Time	Display the date and time of the camera
2	Set the Time	<ul style="list-style-type: none"> <li>Set Manually: Set time manually</li> <li>Synchronize with computer time: Set the camera time according to the computer time</li> <li>Synchronize with SNTP server: Set the camera time synchronously with the SNTP server</li> </ul> <Remark> SNTP server address: Please change in network setting

5.3.11 Maintenance

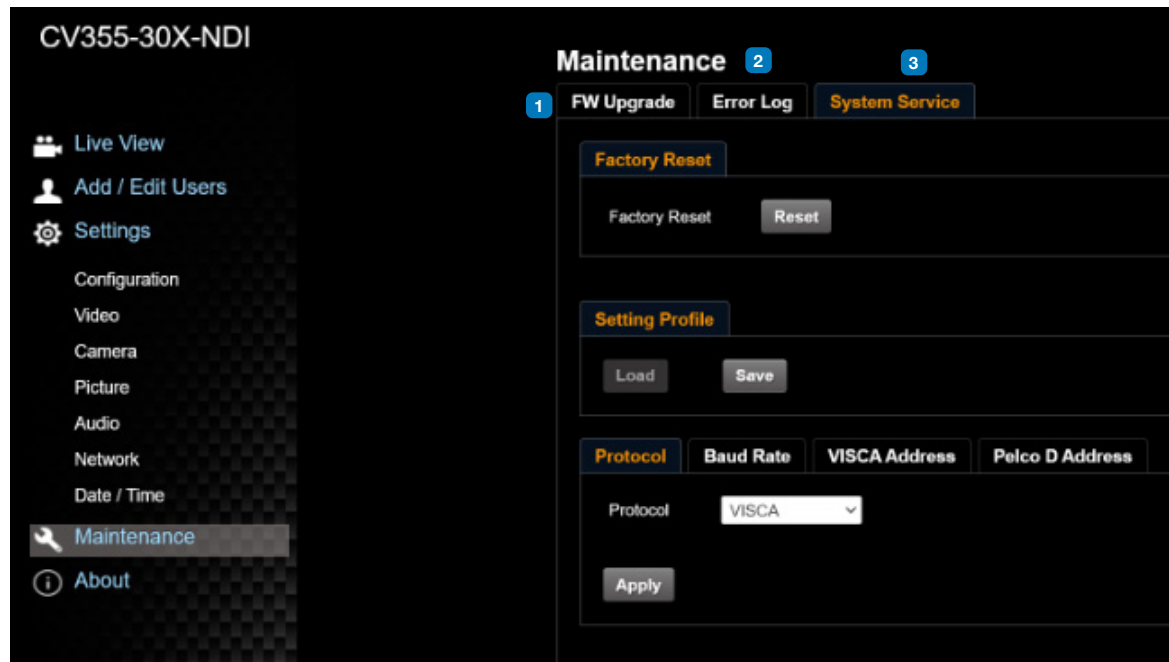

5.3.12 About

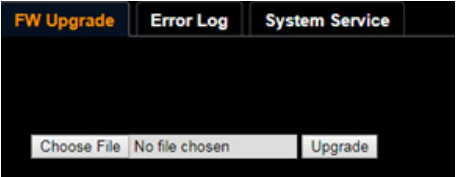
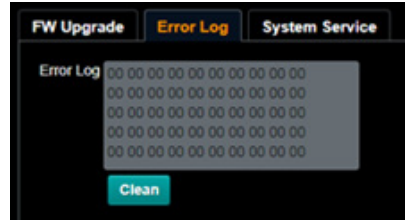

No.	Item.	Function Descriptions
1	Firmware Update	 <p>The camera firmware may be upgraded via web page. For the upgrade method, please download the FW upgrade manual from Marshall website</p>
	Error Logs	 <p>If the camera encounters errors, an error code log will be established</p>
	System Service	<ul style="list-style-type: none"> <li>Factory Reset: Select the reset button to resume the factory default setting as the web page setting</li> <li>Setting Profile: The web page setting parameters can be exported from the computer and imported/applied to another camera</li> <li>Protocol: Set the camera Baud Rate and control protocol for the use of connecting RS-232 communication</li> </ul>

No.	Item.	Function Descriptions
1	Camera ID	Display the camera name
2	Firmware Version	Display the firmware version of the camera
3	Detail Information	Display the completed firmware version of the camera
3	Serial Number	Display the camera serial No.

## 6. Troubleshooting

This chapter describes problems you may encounter while using CV355-30X-NDI. If you have questions, please refer to related chapters and follow all the suggested solutions. If the problem remains, please contact your distributor or the service center.

No.	Problem	Solution
1	Boot without power signal	<ol style="list-style-type: none"><li>1. Make sure you have plugged in the power cord.</li><li>2. When using a PoE connection, ensure that the power supply supports IEEE 802.3af hubs</li></ol>
2	There is no image output from CV355-30X-NDI	<ol style="list-style-type: none"><li>1. Check the power supply or PoE supply functions.</li><li>2. Confirm the output signals are in streaming output.</li><li>3. If the camera is connected to a monitor, confirm the monitor equipment supports 4K output</li><li>4. Replace the cables and make sure they are not faulty.</li></ol>
3	CV355-30X-NDI image is severely delayed	Please use 4K, 1080p or 720p 60/50 Hz signals rather than 25/30 Hz signals.
4	RS-232 cannot be controlled	<ol style="list-style-type: none"><li>1. Confirm the connection is correct (RS-232 Input / Output).</li><li>2. Please make sure the Baud rate setting is the same as the control equipment.</li></ol>
5	Whether the Internet can be used for operation	Please refer to Chapter 5 Network Function Description for the Internet usage or call marshall tech support.

## Warranty

For Warranty information please refer to Marshall website page:

<https://marshall-usa.com/company/warranty.php>

# Marshall

20608 Madrona Avenue, Torrance, CA 90503

Tel: (800) 800-6608 / (310) 333-0606 • Fax: 310-333-0688

[www.marshall-usa.com](http://www.marshall-usa.com)

[support@marshall-usa.com](mailto:support@marshall-usa.com)